

## ELECTRIFYING AND PROVIDING DIGITAL ACCESS IN RURAL SCHOOLS (CLOUD-BASED LEARNING PLATFORMS)

### SCHOOL POWERED ON SOLAR



- Strengthen the participation of local communities in improving water and sanitation management.
- Diffusion of environmentally sound technology in developing countries on concessional terms.
- Access to adequate and equitable sanitation and hygiene; end open defecation.
- Universal and equitable access to safe and affordable drinking water for all.
- Build and upgrade education facilities.



SMART USB SOLAR CHARGER, 5V, 5AMP



- Solar and digital hardware, along with the learning and support required to ensure that children get the benefit of digital learning opportunities.
- The Cloud-Based Learning is setup with tablets, an LED T.V., a Raspberry Pi Server, all powered by Solar Electricity.
- Cloud-Based Learning, children were able to learn from the safety and comfort of their homes under the program - Tablet in Every hamlet.

Design, Manufactured and Marketed by:  
**LUXLIGHTING TECHNOLOGY PRIVATE LIMITED**

CIN : U29309DL2017PTC313599 | GSTIN :07AADCL2486K1Z7  
Regd. : B-232/1, Birla Farm Chhattarpur Extension, New Delhi - 110 074

For feedback & queries, please contact:

**+91-9350831213, +91-11-65666883**

[suraj@luxlighting.in](mailto:suraj@luxlighting.in) | [www.luxlighting.in](http://www.luxlighting.in)

SCAN & FOLLOW US ON :



SCAN & SEND MESSAGE :



# Mobile Charging Cart

Organized, Secure, & Efficient Charging.

**Labosys**<sup>®</sup>  
Technology Benefiting Humanity [www.labosys.in](http://www.labosys.in)



## Highlights

- 48 internal USB ports provide up to 2.4A apiece for fast charging of tablets
- Sturdy steel construction with locking doors that help prevent theft or tampering
- Supports charging of iPad, Android, Surface, Kindle and other USB tablets
- Flow-through ventilation helps prevent connected tablets from overheating
- 10 ft. cord with NEMA 5-15P plug allows great flexibility in reaching AC outlets.

## Package Includes

- LS48USB Multi-Device Charging Station, Black
- Detachable AC input cord with NEMA 5-15P plug, 10 ft. (3.1 m)
- (2) Keys
- Owner's manual

## Multi-Device Charging Station, 48/60 USB Ports, iPad and Android Tablets



M: +91 8130383561, 9350831213 | E:cto@labosys.in

SCAN & SEND MESSAGE :



SCAN & FOLLOW US ON :



# Mobile Charging Cart

Organized, Secure, & Efficient Charging.



## Multi-Device Charging Station, 48/60 USB Ports, iPad and Android Tablets

**Grid Powered**  
**Solar Powered**

**Adapter Charging**  
**Universal Socket**

**Biometric**  
**Access Control**

**Temperature**  
**Monitoring**

**UVC Sterilization**  
**Protection**

Locking steel cabinet provides 2.4A USB charging, syncing, secure storage and cord management for up to 48 tablets and other USB devices.

### Features

#### Multi-Device Charging Station Accommodates up to 48 iPads and Other Tablets

The 120V LS48USB provides USB charging, device syncing, secure storage and cord management for as many as 48 iPad, Android, Surface, Kindle and other USB tablets, smartphones and devices. The connected devices' chargers connect to the charging station's 48 USB ports, which provide the fastest charging supported by each device up to 2.4A per port.

#### Locking Steel Enclosure Keeps Valuable Equipment Safe and Secure

Constructed from heavy-duty steel covered with a powder-coated finish, this tablet charging station provides safe, secure storage. Doors lock with the included keys to help prevent theft, damage and tampering. Flow-through ventilation helps protect against overheating, and the specially coated shelves help prevent device scratches and scuffs.

#### Supports Convenient Syncing

The USB sync uplink port connects to a host computer for wired or wireless syncing. The LS48USB can sync and charge devices at the same time, up to 1.5A charging per port during wired syncing.

#### Comes Fully Assembled for Immediate Use

The LS48USB ships fully assembled and supports mounting to a wall, desk, table, counter or floor. The front door opens 180 degrees to allow full access to the interior. Removable dividers accommodate thicker USB devices. A firmware upgrade port allows future updates. To move the charging station from room to room, you may convert it to a mobile cart using the optional LSHANDLEKIT accessory (sold separately). A detachable 10-foot (3.1-meter) power cord with NEMA 5-15P plug connects the charging station to an available AC outlet.

OVERVIEW	Grid Power 230Vac / 110Vac	Solar / or DC 24Vdc
UPC Code	LSCS0048AC	LSCS0048DC
Product Type	Multi-Device Charger	Multi-Device Charger
Charging Form Factor	Stationary Cabinet	Stationary Cabinet
Charger Functions	Charge; Secure; Sync	Charge; Secure; Sync
Device Compatibility	Tablet; Phone	Tablet; Phone
Device Slots	48	48
INPUT		
Nominal Input Voltage(s) Supported	120V AC; 230V AC	24Vdc
Voltage Compatibility (VAC)	110-240	18 to 30Vac
Input Frequency	50 / 60 Hz (auto-select)	DC Solar / Battery
Input Plug Type	NEMA 5-15P	NEMA 5-15P
Input Cord Length (ft.)	10	10
Input Cord Length (m)	3.05	3.05

M: +91 8130383561, 9350831213 | E:cto@labosys.in

SCAN & SEND MESSAGE :



SCAN & FOLLOW US ON :



# Mobile Charging Cart

Organized, Secure, & Efficient Charging.



Multi-Device Charging Station, 48/60 USB Ports, iPad and Android Tablets

**Grid Powered  
Solar Powered**

**Adapter Charging  
Universal Socket**

**Biometric  
Access Control**

**Temperature  
Monitoring**

**UVC Sterilization  
Protection**



POWER	Grid Power 230Vac / 110Vac	Solar / or DC 24Vdc
Power Consumption (Watts)	224	224
<b>CHARGING</b>		
Number of Charging Ports	48	48
Total Charging Amps	120A	120A
Total Charging Watts	600	600
Charging Method	USB	USB
Charging Port Type	USB A (FEMALE)	USB A (FEMALE)
Charging Ports Details	Pass through	Pass through
Charging Ports / Amps	(48) 2.4A	(48) 2.4A
Overcharge Protection	Yes	Yes
Charging Amps per Port	2.4A	2.4A
<b>PHYSICAL</b>		
Color	Black	Black
Material of Construction	Steel	Steel
Charging Station Form Factor	Stationary Cabinet	Stationary Cabinet
Shipping Dimensions (hwd / in.)	41.02 x 28.35 x 26.38	41.02 x 28.35 x 26.38
Shipping Dimensions (hwd / cm)	104.19 x 72.01 x 67.01	104.19 x 72.01 x 67.01
Shipping Weight (lbs.)	183	183
Shipping Weight (kg)	83.01	83.01
Slot Dimensions - Bottom (hwd / in.)	8.0 x 0.8 x 13.9	8.0 x 0.8 x 13.9
	204 x 20,1 x 353.8	204 x 20,1 x 353.8
Slot Dimensions - Middle (hwd / in.)	8.0 x 0.8 x 13.9	8.0 x 0.8 x 13.9
Slot Dimensions - Middle (hwd / mm)	204 x 20,1 x 353.8	204 x 20,1 x 353.8
Slot Dimensions - Top (hwd / in.)	8.1 x 0.8 x 13.9	8.1 x 0.8 x 13.9
Slot Dimensions - Top (hwd / mm)	206 x 20,1 x 353.8	206 x 20,1 x 353.8
Unit Dimensions (hwd / in.)	35.630 x 23.620 x 21.570	35.630 x 23.620 x 21.570
Unit Dimensions (hwd / cm)	90.42 x 59.9 x 54.86	90.42 x 59.9 x 54.86
Unit Weight (lbs.)	150	150
Unit Weight (kg)	68.04	68.04
Number of Shelves	3	3
<b>FEATURES &amp; SPECIFICATIONS</b>		
Antimicrobial	No	No
Built-In Circuit Breaker	Yes	Yes
Cord Management	Yes	Yes
Overcurrent Protection	Yes	Yes
EMI/RFI Line Noise Protection	Yes	Yes
Flow-Through Ventilation	Yes	Yes
IP68 Rated	No	No
IP20 Rated	No	No
UV Sterilization	No	No
Locking	Yes	Yes
Lock Type	Key	Key
<b>STANDARDS &amp; COMPLIANCE</b>		
Product Certifications	NOM (Mexico); UL 60950-1	NOM (Mexico); UL 60950-1
Product Compliance	RoHS; CE (Europe); EIA/ECA-310-E; REACH; FCC Part 15 Class B (USA)	RoHS; CE (Europe); EIA/ECA-310-E; REACH; FCC Part 15 Class B (USA)
<b>WARRANTY &amp; SUPPORT</b>		
	2-year limited warranty	2-year limited warranty
<b>CATEGORY PAGE FILTERS (Y/N ONLY)</b>		
External Receptacle	No	No

M: +91 8130383561, 9350831213 | E:cto@labosys.in

SCAN & SEND MESSAGE :



SCAN & FOLLOW US ON :



# Mobile Charging Cart

Organized, Secure, & Efficient Charging.

**LaboSys**<sup>®</sup>  
Technology Benefiting Humanity [www.labosys.in](http://www.labosys.in)

Multi-Device Charging Station, 48/60 USB Ports, iPad and Android Tablets

- Grid Powered
- Solar Powered
- Adapter Charging
- Universal Socket
- Biometric Access Control
- Temperature Monitoring
- UVC Sterilization Protection



M: +91 8130383561, 9350831213 | E:cto@labosys.in

SCAN & SEND MESSAGE :



SCAN & FOLLOW US ON :



Proprietary Designs Disclaimer – LaboSys all product and engineering solutions are proprietary designs for software, control, operational process, colour, electronics design, shelves arrangement physical constructions and form factor.

# Mobile Charging Cart

Organized, Secure, & Efficient Charging.

**LaboSys**<sup>®</sup>  
Technology Benefiting Humanity [www.labosys.in](http://www.labosys.in)

Multi-Device Charging Station, 48/60 USB Ports, iPad and Android Tablets

**Grid Powered**  
**Solar Powered**

**Adapter Charging**  
**Universal Socket**

**Biometric**  
**Access Control**

**Temperature**  
**Monitoring**

**UVC Sterilization**  
**Protection**



M: +91 8130383561, 9350831213 | E:cto@labosys.in

SCAN & SEND MESSAGE :



SCAN & FOLLOW US ON :



Proprietary Designs Disclaimer – LaboSys all product and engineering solutions are proprietary designs for software, control, operational process, colour, electronics design, shelves arrangement physical constructions and form factor.

# Mobile Charging Cart

Organized, Secure, & Efficient Charging.

**Labosys**<sup>®</sup>  
Technology Benefiting Humanity [www.labosys.in](http://www.labosys.in)

Multi-Device Charging Station, 48/60 USB Ports, iPad and Android Tablets

**Grid Powered**  
**Solar Powered**

**Adapter Charging**  
**Universal Socket**

**Biometric**  
**Access Control**

**Temperature**  
**Monitoring**

**UVC Sterilization**  
**Protection**



M: +91 8130383561, 9350831213 | E:cto@labosys.in

SCAN & SEND MESSAGE :



SCAN & FOLLOW US ON :



Proprietary Designs Disclaimer – Labosys all product and engineering solutions are proprietary designs for software, control, operational process, colour, electronics design, shelves arrangement physical constructions and form factor.

# Mobile Charging Cart

Organized, Secure, & Efficient Charging.

**LaboSys**<sup>®</sup>  
Technology Benefiting Humanity [www.labosys.in](http://www.labosys.in)

Multi-Device Charging Station, 48/60 USB Ports, iPad and Android Tablets

- Grid Powered
- Solar Powered
- Adapter Charging
- Universal Socket
- Biometric Access Control
- Temperature Monitoring
- UVC Sterilization Protection



M: +91 8130383561, 9350831213 | E:cto@labosys.in

SCAN & SEND MESSAGE :



SCAN & FOLLOW US ON :



Proprietary Designs Disclaimer - LaboSys all product and engineering solutions are proprietary designs for software, control, operational process, colour, electronics design, shelves arrangement physical constructions and form factor.

# Mobile Charging Cart

Organized, Secure, & Efficient Charging.

**LaboSys**<sup>®</sup>  
Technology Benefiting Humanity [www.labosys.in](http://www.labosys.in)

Multi-Device Charging Station, 48/60 USB Ports, iPad and Android Tablets

**Grid Powered**  
**Solar Powered**

**Adapter Charging**  
**Universal Socket**

**Biometric**  
**Access Control**

**Temperature**  
**Monitoring**

**UVC Sterilization**  
**Protection**



M: +91 8130383561, 9350831213 | E:cto@labosys.in

SCAN & SEND MESSAGE :



WhatsApp

SCAN & FOLLOW US ON :



LinkedIn



Twitter



Website



YouTube

Proprietary Designs Disclaimer - LaboSys all product and engineering solutions are proprietary designs for software, control, operational process, colour, electronics design, shelves arrangement physical constructions and form factor.

# Mobile Charging Cart

Organized, Secure, & Efficient Charging.

**Labosys**<sup>®</sup>  
Technology Benefiting Humanity [www.labosys.in](http://www.labosys.in)

Multi-Device Charging Station, 48/60 USB Ports, iPad and Android Tablets

**Grid Powered**  
**Solar Powered**

**Adapter Charging**  
**Universal Socket**

**Biometric**  
**Access Control**

**Temperature**  
**Monitoring**

**UVC Sterilization**  
**Protection**



M: +91 8130383561, 9350831213 | E:cto@labosys.in

SCAN & SEND MESSAGE :



SCAN & FOLLOW US ON :



Proprietary Designs Disclaimer – Labosys all product and engineering solutions are proprietary designs for software, control, operational process, colour, electronics design, shelves arrangement physical constructions and form factor.

# Mobile Charging Cart

Organized, Secure, & Efficient Charging.

**LaboSys**<sup>®</sup>  
Technology Benefiting Humanity [www.labosys.in](http://www.labosys.in)

Multi-Device Charging Station, 48/60 USB Ports, iPad and Android Tablets

- Grid Powered
- Solar Powered
- Adapter Charging
- Universal Socket
- Biometric Access Control
- Temperature Monitoring
- UVC Sterilization Protection



M: +91 8130383561, 9350831213 | E:cto@labosys.in

SCAN & SEND MESSAGE :



SCAN & FOLLOW US ON :



Proprietary Designs Disclaimer – LaboSys all product and engineering solutions are proprietary designs for software, control, operational process, colour, electronics design, shelves arrangement physical constructions and form factor.

# Mobile Charging Cart

Organized, Secure, & Efficient Charging.

**Labosys**<sup>®</sup>  
Technology Benefiting Humanity [www.labosys.in](http://www.labosys.in)

Multi-Device Charging Station, 48/60 USB Ports, iPad and Android Tablets

- Grid Powered
- Solar Powered
- Adapter Charging
- Universal Socket
- Biometric Access Control
- Temperature Monitoring
- UVC Sterilization Protection



M: +91 8130383561, 9350831213 | E:cto@labosys.in

SCAN & SEND MESSAGE :



SCAN & FOLLOW US ON :



Proprietary Designs Disclaimer – Labosys all product and engineering solutions are proprietary designs for software, control, operational process, colour, electronics design, shelves arrangement physical constructions and form factor.

# Mobile Charging Cart

Organized, Secure, & Efficient Charging.

**Labosys**<sup>®</sup>  
Technology Benefiting Humanity [www.labosys.in](http://www.labosys.in)

Multi-Device Charging Station, 48/60 USB Ports, iPad and Android Tablets

**Grid Powered**  
**Solar Powered**

**Adapter Charging**  
**Universal Socket**

**Biometric**  
**Access Control**

**Temperature**  
**Monitoring**

**UVC Sterilization**  
**Protection**



M: +91 8130383561, 9350831213 | E:cto@labosys.in

SCAN & SEND MESSAGE :



SCAN & FOLLOW US ON :



Proprietary Designs Disclaimer – Labosys all product and engineering solutions are proprietary designs for software, control, operational process, colour, electronics design, shelves arrangement physical constructions and form factor.

# Mobile Charging Cart

Organized, Secure, & Efficient Charging.

**Labosys**<sup>®</sup>  
Technology Benefiting Humanity [www.labosys.in](http://www.labosys.in)

Multi-Device Charging Station, 48/60 USB Ports, iPad and Android Tablets

**Grid Powered**  
**Solar Powered**

**Adapter Charging**  
**Universal Socket**

**Biometric**  
**Access Control**

**Temperature**  
**Monitoring**

**UVC Sterilization**  
**Protection**



M: +91 8130383561, 9350831213 | E:cto@labosys.in

SCAN & SEND MESSAGE :



SCAN & FOLLOW US ON :



Proprietary Designs Disclaimer – Labosys all product and engineering solutions are proprietary designs for software, control, operational process, colour, electronics design, shelves arrangement physical constructions and form factor.

# Mobile Charging Cart

Organized, Secure, & Efficient Charging.

**Labosys**<sup>®</sup>  
Technology Benefiting Humanity [www.labosys.in](http://www.labosys.in)

Multi-Device Charging Station, 48/60 USB Ports, iPad and Android Tablets

**Grid Powered**  
**Solar Powered**

**Adapter Charging**  
**Universal Socket**

**Biometric**  
**Access Control**

**Temperature**  
**Monitoring**

**UVC Sterilization**  
**Protection**



M: +91 8130383561, 9350831213 | E:cto@labosys.in

SCAN & SEND MESSAGE :



SCAN & FOLLOW US ON :



Proprietary Designs Disclaimer – Labosys all product and engineering solutions are proprietary designs for software, control, operational process, colour, electronics design, shelves arrangement physical constructions and form factor.

# Mobile Charging Cart

Organized, Secure, & Efficient Charging.

**Labosys**<sup>®</sup>  
Technology Benefiting Humanity [www.labosys.in](http://www.labosys.in)

Multi-Device Charging Station, 48/60 USB Ports, iPad and Android Tablets

**Grid Powered**  
**Solar Powered**

**Adapter Charging**  
**Universal Socket**

**Biometric**  
**Access Control**

**Temperature**  
**Monitoring**

**UVC Sterilization**  
**Protection**



M: +91 8130383561, 9350831213 | E:cto@labosys.in

SCAN & SEND MESSAGE :



SCAN & FOLLOW US ON :



Proprietary Designs Disclaimer – Labosys all product and engineering solutions are proprietary designs for software, control, operational process, colour, electronics design, shelves arrangement physical constructions and form factor.

# Mobile Charging Cart

Organized, Secure, & Efficient Charging.

**Labosys**<sup>®</sup>  
Technology Benefiting Humanity [www.labosys.in](http://www.labosys.in)

Multi-Device Charging Station, 48/60 USB Ports, iPad and Android Tablets

- Grid Powered
- Solar Powered
- Adapter Charging
- Universal Socket
- Biometric
- Access Control
- Temperature
- Monitoring
- UVC Sterilization
- Protection



M: +91 8130383561, 9350831213 | E:cto@labosys.in

SCAN & SEND MESSAGE :



SCAN & FOLLOW US ON :



Proprietary Designs Disclaimer – Labosys all product and engineering solutions are proprietary designs for software, control, operational process, colour, electronics design, shelves arrangement physical constructions and form factor.

# Mobile Charging Cart

Organized, Secure, & Efficient Charging.

**Labosys**<sup>®</sup>  
Technology Benefiting Humanity [www.labosys.in](http://www.labosys.in)

Multi-Device Charging Station, 48/60 USB Ports, iPad and Android Tablets

- Grid Powered
- Solar Powered
- Adapter Charging
- Universal Socket
- Biometric Access Control
- Temperature Monitoring
- UVC Sterilization Protection



M: +91 8130383561, 9350831213 | E:cto@labosys.in

SCAN & SEND MESSAGE :



SCAN & FOLLOW US ON :



Proprietary Designs Disclaimer – Labosys all product and engineering solutions are proprietary designs for software, control, operational process, colour, electronics design, shelves arrangement physical constructions and form factor.

6

5

4

3

2

1

Top View

485

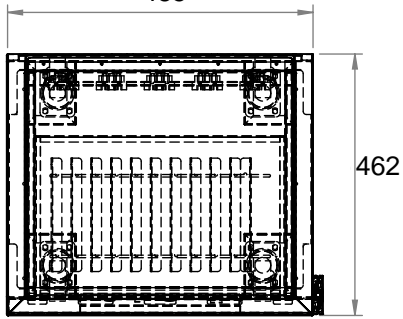

462

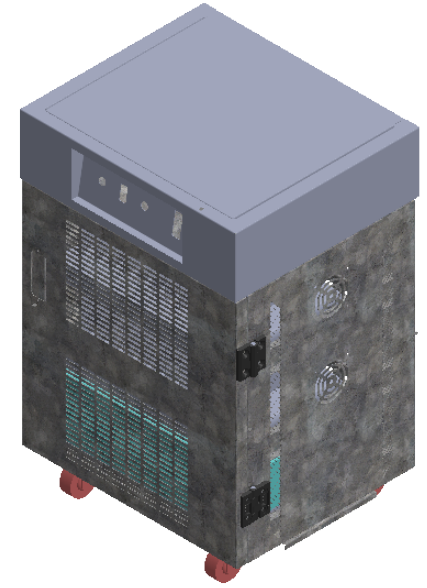

485

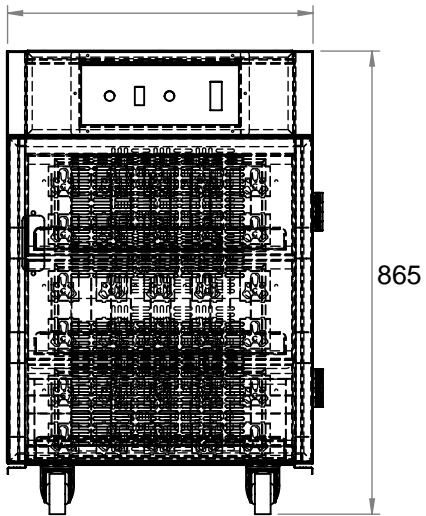

865

Front View

462

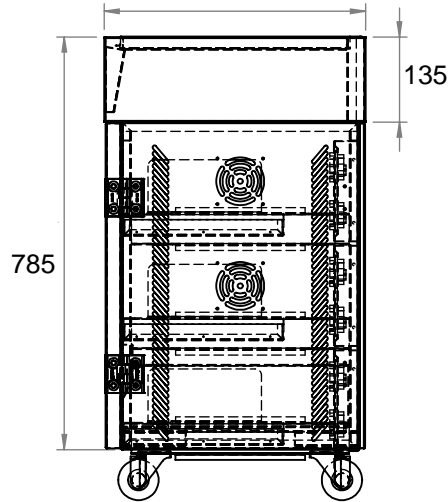

785

135

Side View

All Dimension in mm

DATE	PREP	CHK'D	APP'VD
14-10-2025	VISHAL		
TITLE: [20] - MOBILES CHARGING STATION			
MATERIAL: _____		DWG NO.- _____	
FINISH: _____		PART NO.- _____	
PART NAME: _____			A4 SHEET 1 OF 1

A4

SHEET 1 OF 1

6

5

4

3

2

1

D

D

C

C

B

B

A

A

6

5

4

3

2

1

Top View

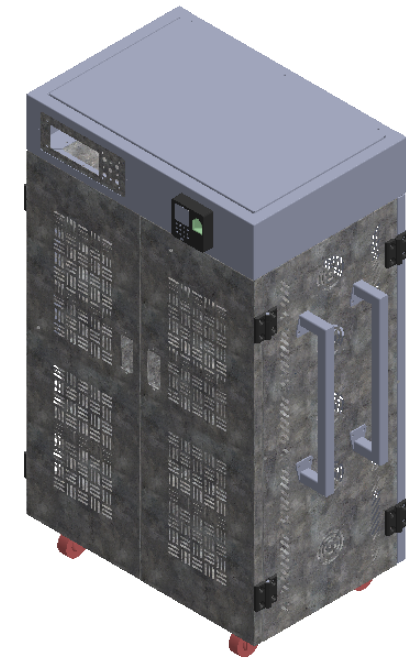
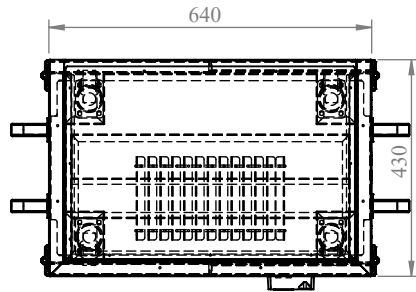

640

430

Front View

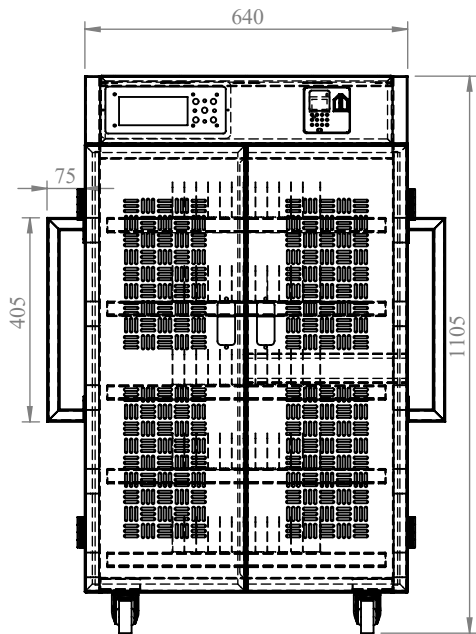

Side View

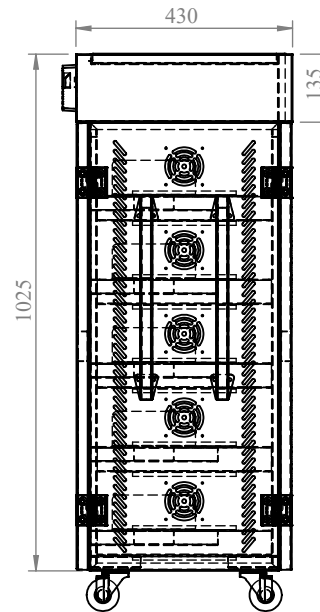

All Dimension in mm

DATE	PREP	CHK'D	APP'VD
08-08-2025	VISHAL		
TITLE: 60-MOBILES CHARGING STATION			
MATERIAL: _____	DWG NO.- _____		
FINISH: _____	PART NO.- _____		
PART NAME: _____			

6

5

4

3

2

1

D

D

C

C

B

B

A

A

6

5

4

3

2

1

Top View

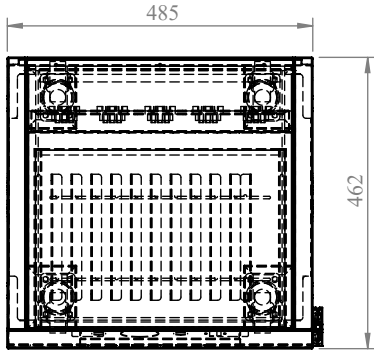

485

462

Front View

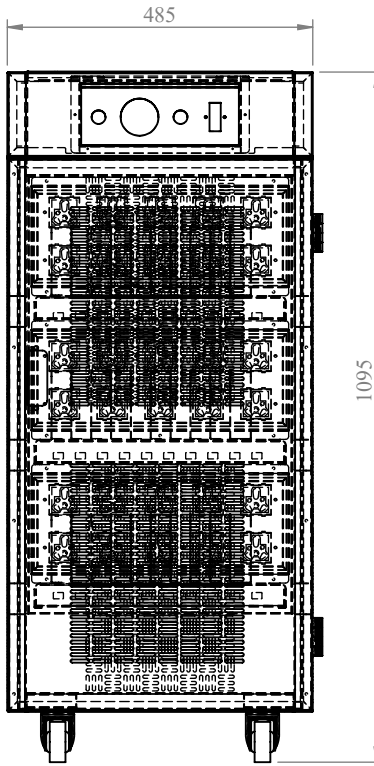

Side View

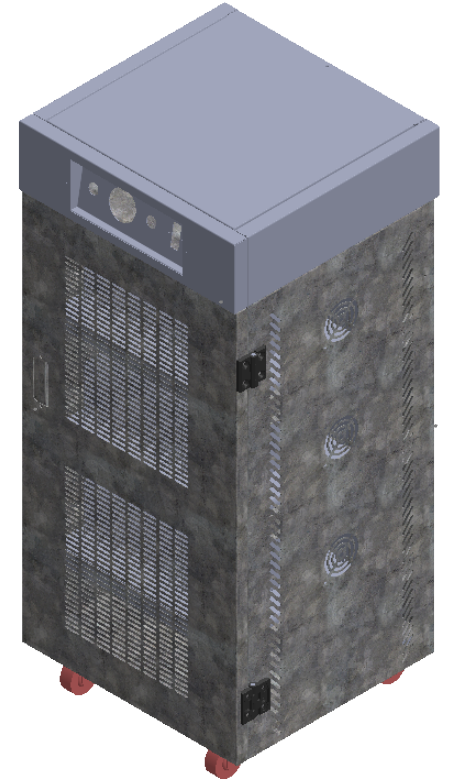
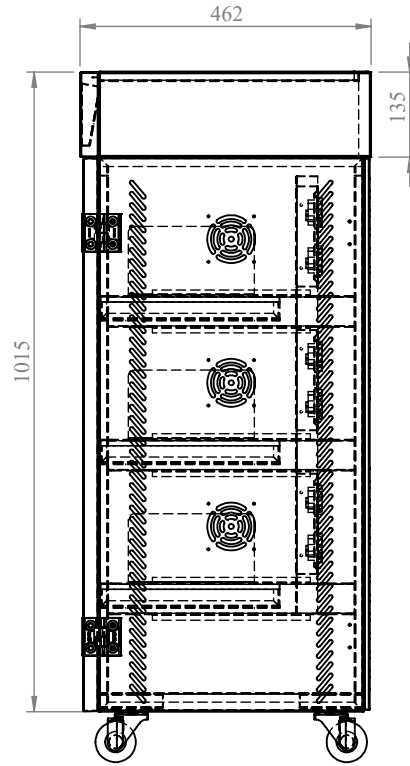

All Dimension in mm

DATE	PREP	CHK'D	APP'VD
17-10-2025	VISHAL		
TITLE: [30] - MOBILES CHARGING STATION			
MATERIAL: _____		DWG NO.- _____	
FINISH: _____		PART NO.- _____	
PART NAME: _____			A4 SHEET 1 OF 1

Lux Med

D

C

B

A

6

5

4

3

2

1